

triton cloud™ panel



High Sound Absorbing Edge Wrapped Ceiling Panel Technical Installation Manual



triton cloudTM panel

High Sound Absorbing Edge Wrapped Ceiling Panel

Technical Installation Manual

Triton CloudTM panels are made with a proprietary edge wrapped glass fibre, high sound absorbing acoustic panel faced with either a SonatexTM glass mat composite acoustic facing, woven glass fabric or wrapped in fabric.

Section	Description	Page
1.0	General information	3
2.0	Technical Installation Specifications	4
3.0	Components and Ancillary Products	5-6
4.0	Installation	7
4.1	Installation – standard, direct fixed with Side Impaling Brackets (SIB)	7-12
4.2	Installation– alternative, direct fixed concealed	13
4.3	Installation - alternative, direct fixed face fixed	14
4.4	Installation - alternative, direct fixed adhesive options	15-16
4.5	Installation – suspended	17
4.6	Installation – suspended to steel framed panel	18
4.7	Installation – high level walls	19-20
4.8	Installation of services	21
5.0	Cutting	22-29
6.0	Access panels	30
7.0	Tools	31-32



triton cloudTM panel

High Sound Absorbing Edge Wrapped Ceiling Panel

1.0 General Information

Description

Triton Cloud™ panels are a proprietary acoustical panel system designed to control unwanted noise reverberation in indoor areas and provide a decorative finish.

Application

Triton Cloud™ panels can be direct fix mounted or suspended under new and existing ceilings or building structures.

Composition

Manufactured in NZ, from non-combustible glass fibre core and faced and edge wrapped in 2 ply Sonatexglass mat laminate. Larger sizes and thicknesses may be framed with concealed steel channel.

General

The installation details and information contained within this Asona Triton Cloud Panel Installation Manual provides an extensive range of construction methods that can be adapted to suit individual projects. Asona Ltd can also provide custom made components should there be a particular requirement.

Disclaimer

“Asona Triton Cloud Panels and components as described must be used and installed in accordance with the installation instructions detailed within this guide. Use of any other installation methods, materials or components may result in component failure and void the warranty of the product and system”



Asona Ltd.
Office and Factory
6 Mahunga Drive, Māngere
Bridge, Auckland 2022
New Zealand

Contact
T: +64(0)9 525 6575
E: info@asona.co.nz
W: www.asona.co.nz
NZBN: 9429036035175

asona

triton cloudTM panel

High Sound Absorbing Edge Wrapped Ceiling Panel

2.0 Technical Installation Specification

Handling & Storage:

- When handling wear white gloves to avoid marking the panels.
- Handle with care, avoid bending and pay special attention to avoid edge damage.
- Store Triton Cloud Panels on a flat dry surface with adequate support to prevent bending.
- Keep dry, clean, and free from dust and debris.
- When storing onsite protect the panels from possible damage by other trades.

Limitations of Use:

For interior use only, and not in direct contact with water.

- Maximum humidity/temperature 99% R/H at 45°C.
- Back loading — No overlay loads, M&E services and point loads to be independently supported.
- Digitally printed images on fabric must be a single image per panel. Due to pattern creep in the printing process pattern alignment cannot be assured. Position panels >20mm apart.

Installation

- The installation of Asona Triton Cloud Panels can be carried out by competent tradesperson or suspended ceiling installers.
- Installation shall not commence until the building is watertight and dry.
- Light/mechanical fittings shall be independently supported.
- Installation shall be in accordance with the selected fixing system and industry standards.

Health & Safety and PPE

- Wear loose long sleeve clothing.
- Safety glasses.
- Clean gloves.
- Dust mask.
- If cutting with power tools use dust extraction.

Seismic Bracing

- For Triton Cloud panels direct attached to the building structure, purlins, beams or battens with solid aluminium brackets, bracing is generally not required.
- If the panels are suspended, attached to a suspended sub structure or a lined suspended ceiling system, then the weight of the Triton Cloud panels shall be included in the seismic design calculations. Install bracing as required by the seismic design.
- For preliminary advice, please contact Asona Ltd.

Weight

3 kg/m² (50mm Cloud). Refer to the Technical Data Sheet for other thicknesses.

Do's

- Use the specified components as detailed in this manual.
- Do ensure there are sufficient attachment points for the size and weight of the panel.
- Control the indoor environment to prevent condensation occurring which could result in surface staining.

Don'ts

- Do not install Asona Triton Cloud Panels until the building is watertight.
- Any items installed into the Asona Triton Cloud Panels must be independently supported.
- Do not install panels within wet areas or where they can come in direct contact with water.

Maintenance

Clean with vacuum, soft brush, or damp cloth. Re-surfacing of soiled panels available, consult Asona.

NZ Building Code Compliance

- B2 Durability – Clause B2.3.1 (c) (i): Asona Triton Cloud with only normal maintenance will have a minimum durability of at least 5 years when installed in accordance with; manufacturer's installation requirements and AS/NZS 2785:2020.
- C3 Fire – Clause C/AS2 3.4(a): Asona Triton Cloud has a Fire Material Group Number 1-S* for Sonatex and selected fabric finishes by NZBC verification method C/VM2 Appendix A, tested in accordance with ISO 5660 or ISO 9705. (NCC BCA C1.10 clause 4, spec A2.4 clause 4. Group 1). Other fabrics 2-S, 2 and 3.

* Subject to minimum installation spacing in accordance with BRANZ Test Report FAR4593-01-2

triton cloudTM panel

High Sound Absorbing Edge Wrapped Ceiling Panel

3.0 Components & Ancillary Products

Cloud Panel



Standard Side Impaling Bracket - (SIB)

FIX.HC5062



25mm Gap Side Impaling Bracket

FIX.HC25L50



Adjustable Side Impaling Bracket 14-40 mm adjustment

FIX.HC14-40L50



Screws - fixing to timber or steel

8g x 25mm or 40mm white button head



Hollow Wall Anchors—expanding types (preferred option)

Use Hollow Wall anchors when installing the Cloud Panels to existing plasterboard ceilings or walls where battens/studs are not located.



Spiral plasterboard screw—screw-in, metal or plastic

Use spiral screws when installing the Cloud Panels to existing 13mm plasterboard ceilings/walls where battens/studs are not located. These provide a secure point in the plasterboard to use the standard white buttonhead screw.

Refer to suppliers specifications and installation.



Asona Ltd.
Office and Factory
6 Mahunga Drive, Māngere
Bridge, Auckland 2022
New Zealand

Contact
T: +64(0)9 525 6575
E: info@asona.co.nz
W: www.asona.co.nz
NZBN: 9429036035175

asona

triton cloudTM panel

High Sound Absorbing Edge Wrapped Ceiling Panel

3.0 Components & Ancillary Products, cont.

Masonry Plug Anchors

Use masonry plug anchors to install into concrete soffits.



Face Fixing Covers—Ø17.5 x 6mm

Snap lid cover used with low profile head screws to fix directly through the Triton Cloud Panel into substrate or framing. Requires Ø5 –6mm x 75mm minimum long screws. Colour white.

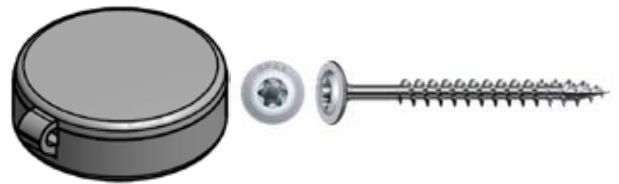

Suspension

Ø2.5 wire suspension x 3600mm



L Bracket

To attach Ø2.5 wire suspension.
To direct fix concealed.

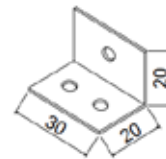

CL-BR20

Rondo DONN DX® grid

Use to attach to Barbed Steel Plate on Cloud panels to enable hidden suspension to the building structure.



Impaling Plates

8-prong Impaling Plate — Use to direct fix Cloud panels to walls.
Barbed Steel Plate — Use to screw:
DONN DX grid on the back of Cloud panels for suspended options.
22 x 19 angle on the back of Cloud panels for direct fix concealed.
Splitrail on the back for wall attachment.



Edge Banding Strips

Sonatex edge banding strips – required for trims less than 50mm, diagonal and notched cuts (consult Asona for required lengths).

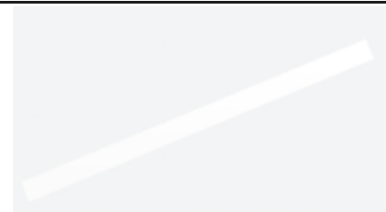

Asona Ltd.
Office and Factory
6 Mahunga Drive, Māngere
Bridge, Auckland 2022
New Zealand

Contact
T: +64(0)9 525 6575
E: info@asona.co.nz
W: www.asona.co.nz
NZBN: 9429036035175

asona

triton cloudTM panel

High Sound Absorbing Edge Wrapped Ceiling Panel

4.0 Installation

4.1 Direct Fix Standard Method

The preferred installation method is to direct mount Triton Cloud Panels to the building structure or substrate lining (eg timber battens, portal beams, purlins, exposed flooring, lined ceilings) using Side Impaling Brackets (SIB).

Direct Fixed Installation of Asona Triton Cloud Panels to Existing Building Framework or Substrate

Installation shall not commence until the building is watertight and dry.

Installation Overview:

Set out panel panels to an architectural RCP or in spaces required.

Timber battens may be required to be installed where direct fixing the SIBs do not align with the building structure elements. Timber battens are parallel and perpendicular to the panel to suit SIB attachment.

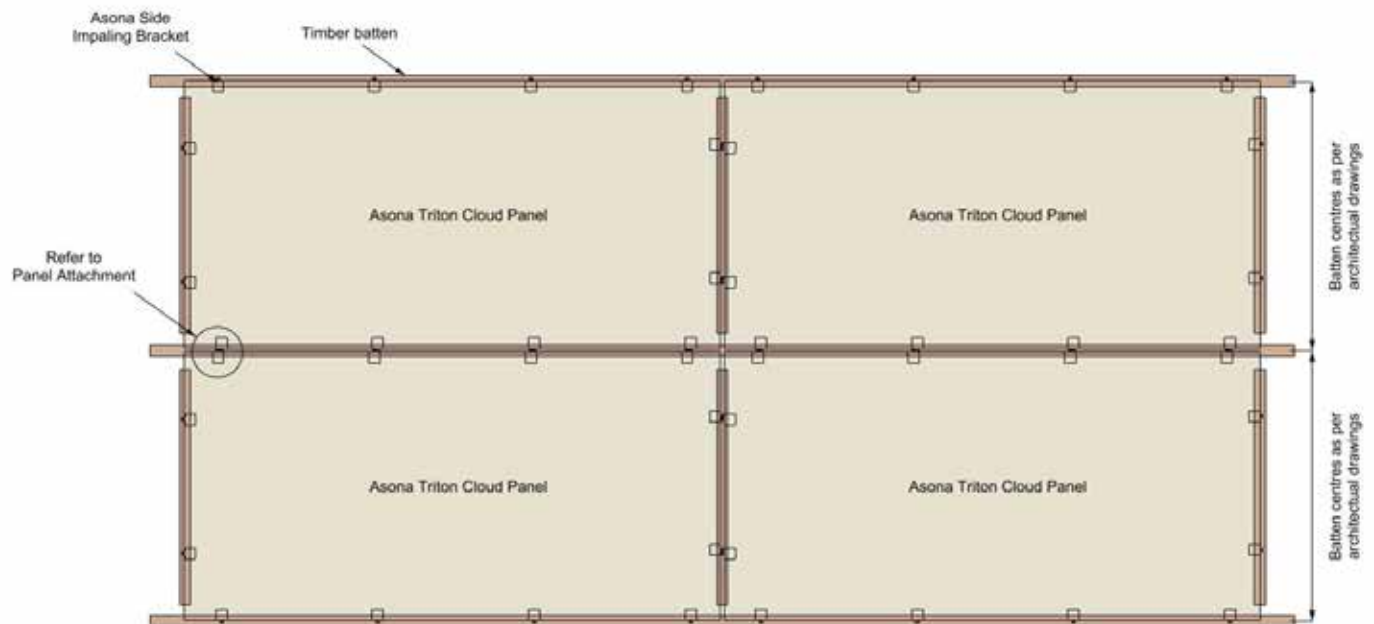

Asona Ltd.
Office and Factory
6 Mahunga Drive, Māngere
Bridge, Auckland 2022
New Zealand

Contact
T: +64(0)9 525 6575
E: info@asona.co.nz
W: www.asona.co.nz
NZBN: 9429036035175

asona

triton cloudTM panel

High Sound Absorbing Edge Wrapped Ceiling Panel

4.0 Installation

Bracket Type:

Select Side Impaling Bracket type appropriate for surface being attached to.

- FIX.HC5062.W.PC for flat or even surfaces.
- FIX.HC25L50.W.PC for a 25mm gap behind the Cloud panel. This allows for slim services to be covered.
- FIX.HC14-40L50.W.PC for uneven surfaces. The slot adjustment allows for a gap of 14mm up to 40mm.

See detail drawings below.

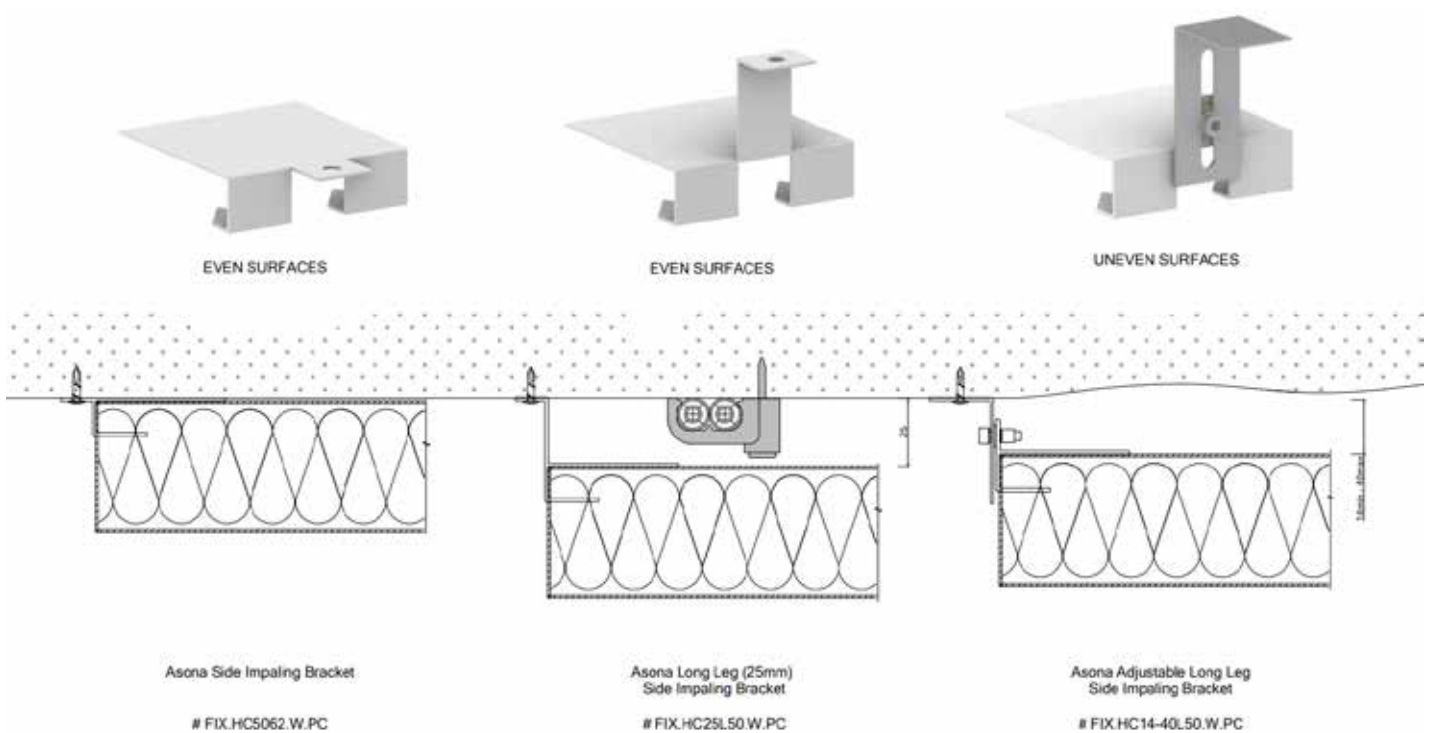

Asona Ltd.
Office and Factory
6 Mahunga Drive, Māngere
Bridge, Auckland 2022
New Zealand

Contact
T: +64(0)9 525 6575
E: info@asona.co.nz
W: www.asona.co.nz
NZBN: 9429036035175

asona

triton cloudTM panel

High Sound Absorbing Edge Wrapped Ceiling Panel

4.0 Installation

Bracket Positioning:

Panels are supported at sides and ends as determined by the sub structure above the panel, and the panel size.

- A minimum of 4 x SIBs per panel shall be used on smaller panel lengths and widths.
- For larger panels 8 –14 brackets shall be used.
- Ensure the Cloud Panel is laid flat on a clean dry surface when attaching brackets.
- Position and install brackets 100 to 150mm from the corner of the panel or on panels as shown.

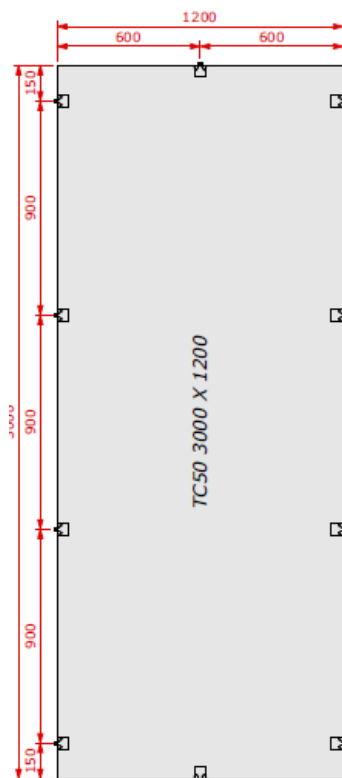

Panel Size	No. Of SIBs
3000 x 1200	x14
2400 x 1200	x12
2400 x 600	x10
1200 x 1200	x8
1200 x 600	x4
600 x 600	x4

Note: Preferred bracket position at 150mm from corner of long side but can be positioned between 100 mm - 300mm

Note: Additional brackets can be installed as required as per site conditions

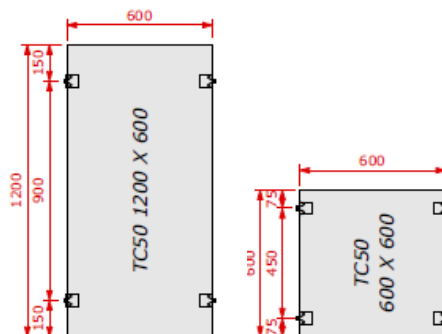
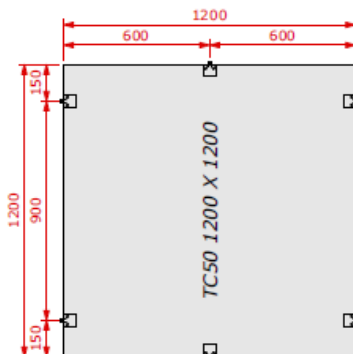

Asona Ltd.
Office and Factory
6 Mahunga Drive, Māngere
Bridge, Auckland 2022
New Zealand

Contact
T: +64(0)9 525 6575
E: info@asona.co.nz
W: www.asona.co.nz
NZBN: 9429036035175



triton cloudTM panel

High Sound Absorbing Edge Wrapped Ceiling Panel

4.0 Installation

Side Impaling Bracket Attachment: (#FIX.HC5062 shown)

Lay the SIB on the back of the Cloud Panel in the required location. Using a side to side rocking motion, push the barbs into the side of the Cloud Panel, ensuring it is fully inserted against the back edge of the SIB.

SIB positioned

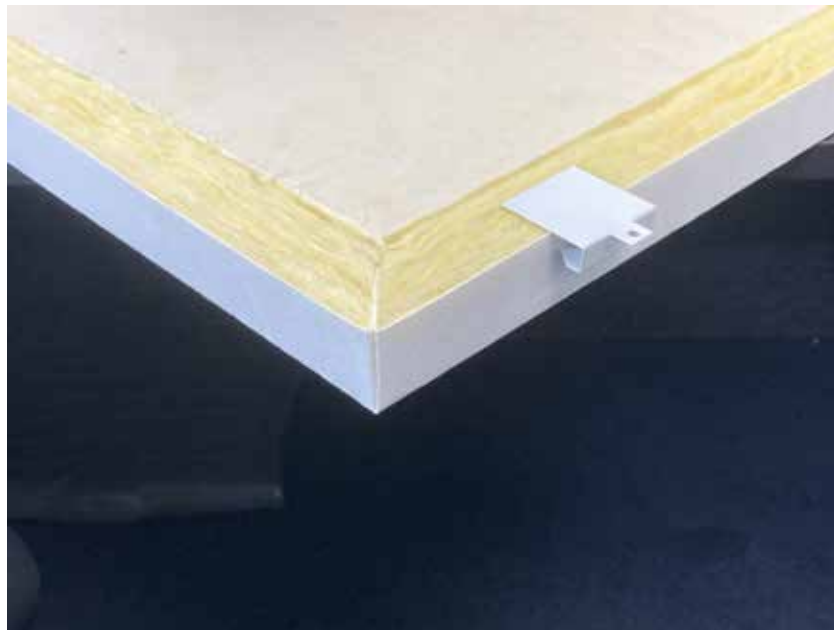

SIB fully inserted

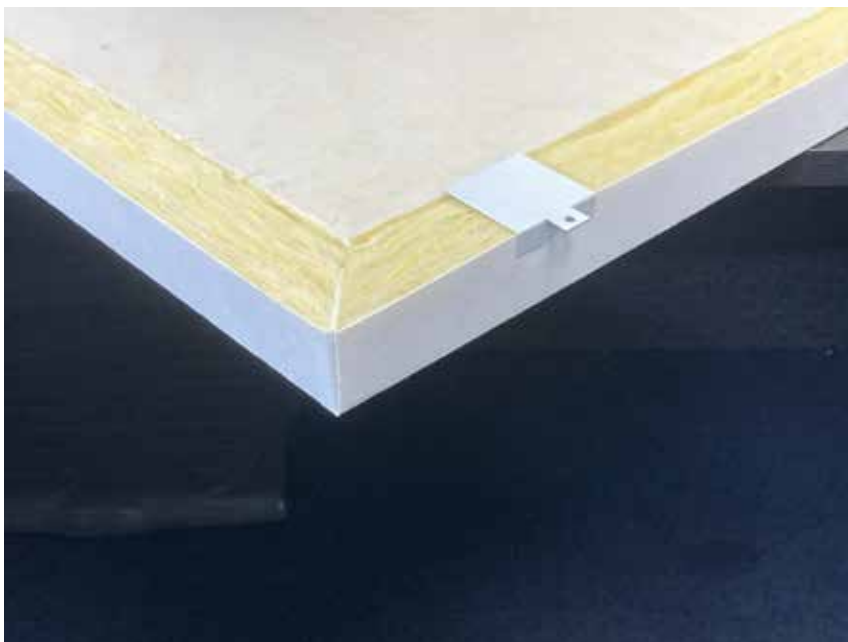

Asona Ltd.
Office and Factory
6 Mahunga Drive, Māngere
Bridge, Auckland 2022
New Zealand

Contact
T: +64(0)9 525 6575
E: info@asona.co.nz
W: www.asona.co.nz
NZBN: 9429036035175

asona

triton cloudTM panel

High Sound Absorbing Edge Wrapped Ceiling Panel

4.0 Installation

Note: Wear white cotton gloves to prevent soiling of the Pool Panel finish.

Panel Installation

Lift the Cloud Panels into position using 2 people or a panel lifter to support the panel. Fix off to the existing substrate using the appropriate fasteners suitable for the material type (timber, aluminium, steel, or concrete). Refer to components schedule.



Panel Attachment:

Option 1—When installing Cloud Panels to timber framing use 40 mm white button head screw.

Option 2—If off-set from timber framing use either expanding or spiral plasterboard wall anchors to secure.

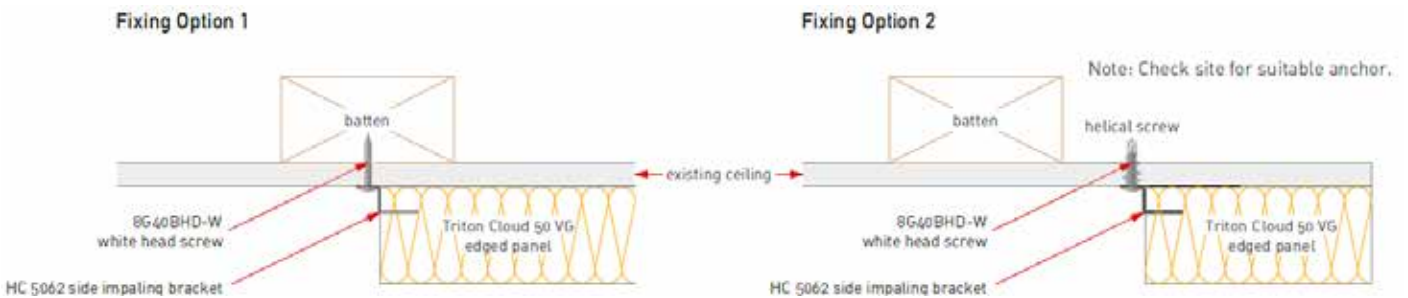

Panel Attachment with Adjacent Panels example:

Allow a 15mm gap minimum between panels to screw the SIBs to the structure. Offset the SIBS so they don't align.

Panel and Bracket Layout

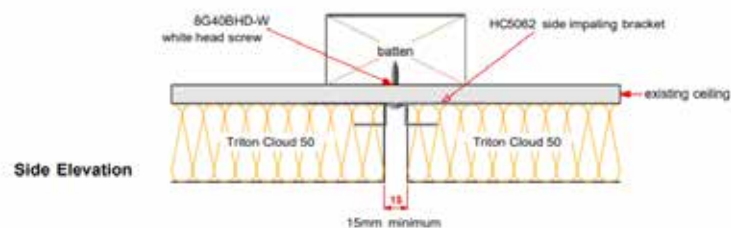
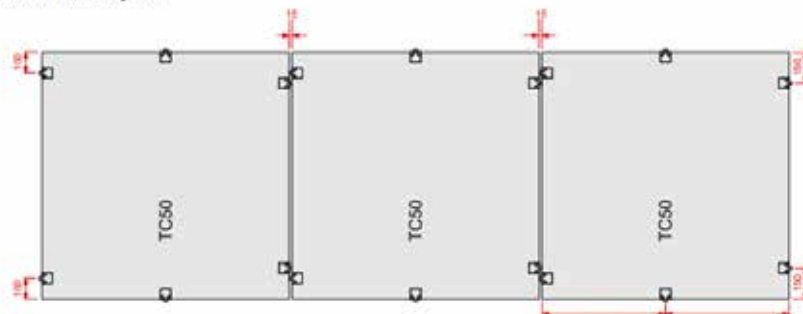

Asona Ltd.
Office and Factory
6 Mahunga Drive, Māngere
Bridge, Auckland 2022
New Zealand

Contact
T: +64(0)9 525 6575
E: info@asona.co.nz
W: www.asona.co.nz
NZBN: 9429036035175

asona

triton cloudTM panel

High Sound Absorbing Edge Wrapped Ceiling Panel

4.0 Installation

Panel Attachment:

When installing Cloud Panels to steel framing use 25mm white button head screw suitable for steel thickness.

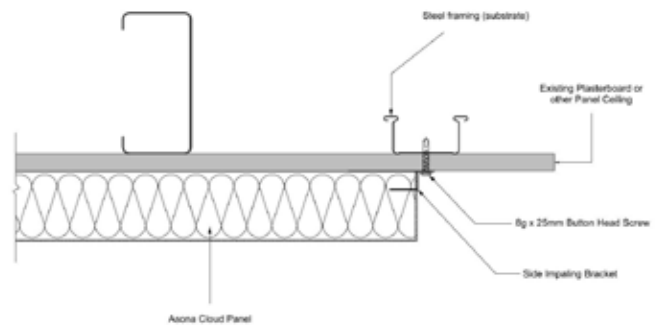

Panel Attachment:

When installing Cloud Panels offset from substrate framing, use expanding type anchor, or 25mm white button head screw into spiral plasterboard screw.

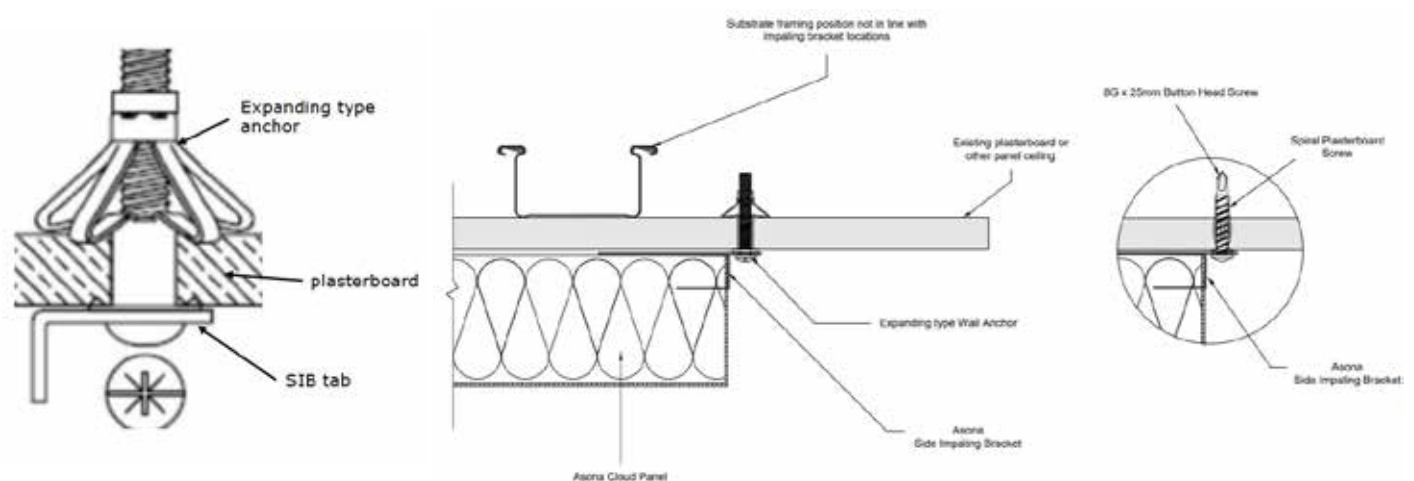

Panel Attachment:

When installing Cloud Panels to a concrete substrate, use 25mm white button head screw into masonry plug anchors.

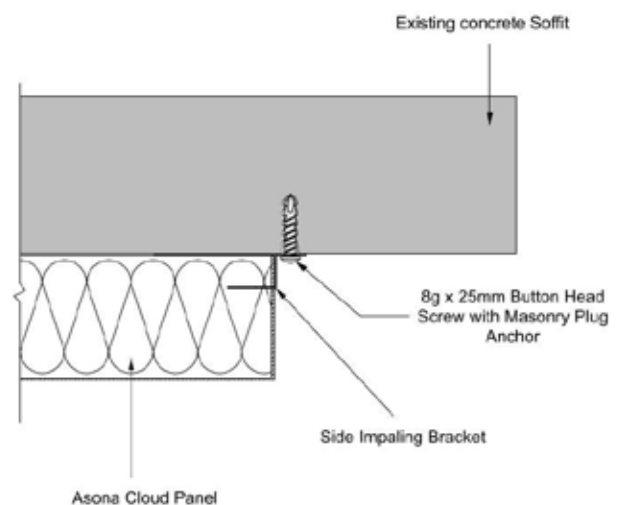

Asona Ltd.
Office and Factory
6 Mahunga Drive, Māngere
Bridge, Auckland 2022
New Zealand

Contact
T: +64(0)9 525 6575
E: info@asona.co.nz
W: www.asona.co.nz
NZBN: 9429036035175

asona

triton cloudTM panel

High Sound Absorbing Edge Wrapped Ceiling Panel

4.0 Installation

4.2 Direct Fix Concealed Fixing Method

Direct Fixed Installation of Asona Triton Cloud Panels to Existing Building Framework or Substrate

Installation shall not commence until the building is watertight and dry.

Installation Overview:

Set out panel panels to an architectural RCP or in spaces required.

Timber battens or angles will be required to be installed to align with the Cloud fixing angles.

NOTE: This method is only suitable for individual Cloud panels or with a 250-300mm minimum gap between panels to enable final installation attachment. Smaller gaps may be possible if a 90° power drill is used for final attachment.

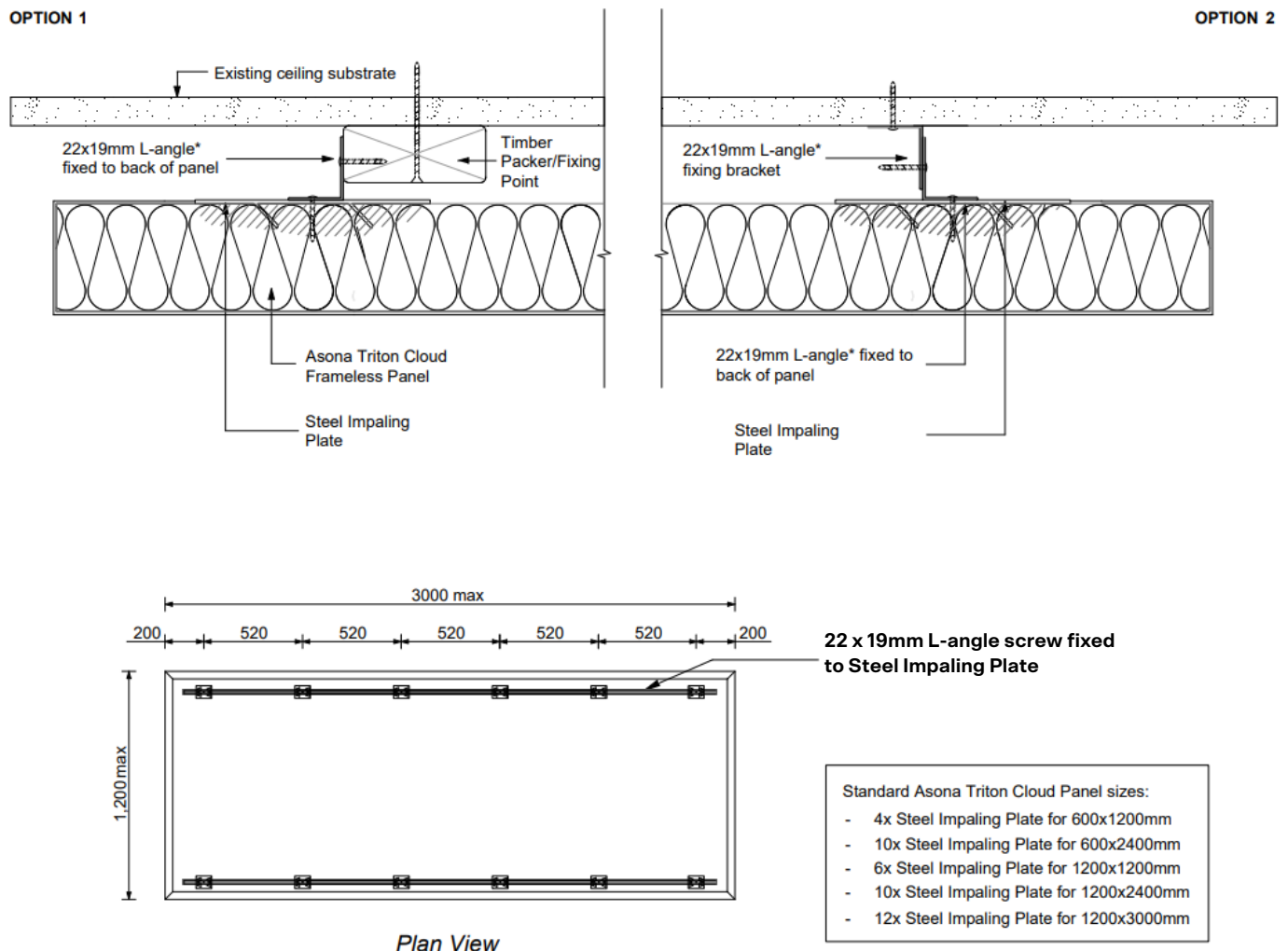

Asona Ltd.
Office and Factory
6 Mahunga Drive, Māngere
Bridge, Auckland 2022
New Zealand

Contact
T: +64(0)9 525 6575
E: info@asona.co.nz
W: www.asona.co.nz
NZBN: 9429036035175

asona

triton cloudTM panel

High Sound Absorbing Edge Wrapped Ceiling Panel

4.0 Installation

4.3 Direct Fix with Face Fixing

Installation shall not commence until the building is watertight and dry.

Cloud Panels can be attached with white face fixings that cover the fastener. Subject to the building structure or ceiling lining, it is recommended to use batten strips to attach the Cloud panels.

Take care not to over tighten screws or to compress the face.



Screw and Cap Washer Locations

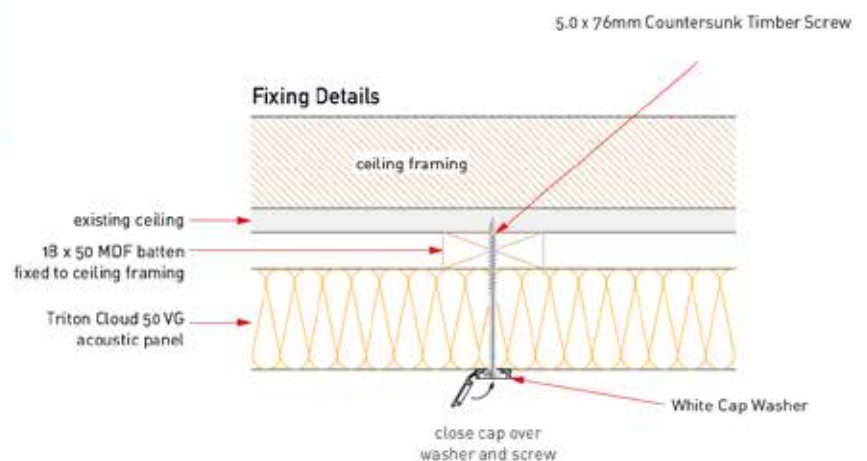
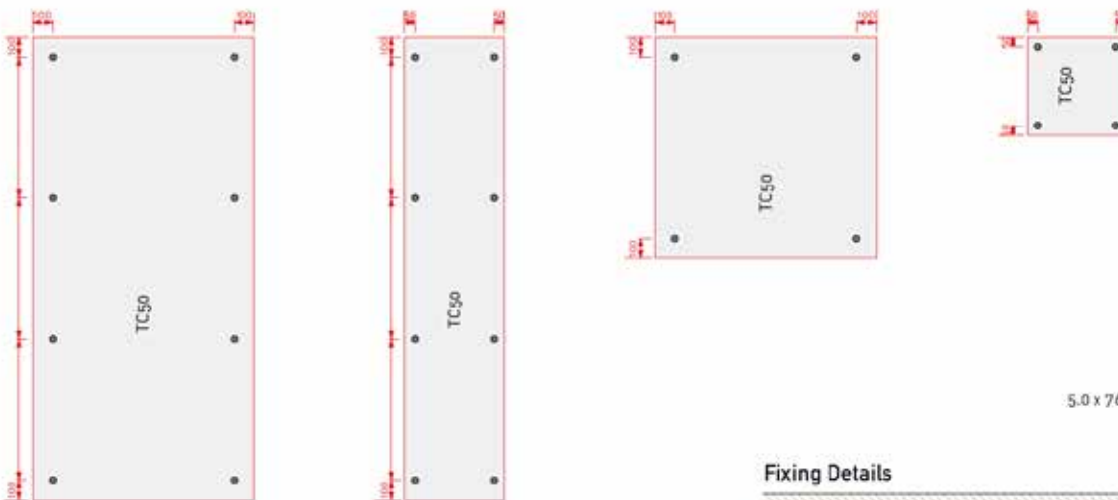

Asona Ltd.
Office and Factory
6 Mahunga Drive, Māngere
Bridge, Auckland 2022
New Zealand

Contact
T: +64(0)9 525 6575
E: info@asona.co.nz
W: www.asona.co.nz
NZBN: 9429036035175

asona

triton cloudTM panel

High Sound Absorbing Edge Wrapped Ceiling Panel

4.0 Installation

4.4 Direct Fixed with Adhesive—option 1

Installation shall not commence until the building is watertight and dry.

Installation Overview:

Triton Cloud Panels may be installed using a combination of adhesives to direct fix to substrates. The substrates must be in a sound condition suitable to attach the Cloud panels, flat, free of dust and any oils or effervescence or any other substance that could prevent the adhesion.

Two types of adhesives are required for this installation method— a contact adhesive and a construction adhesive. The contact adhesive is required to retain the Cloud panel in position while the construction adhesive sets.

Ensure both type of adhesives are suitable for application to the type of substrate of the project.

Contact adhesive type - consult adhesive supplier for suitability of glass fibre to substrate type.

Construction adhesive type — a low viscosity type is required to allow “squash” so the contact adhesive can make contact. (High viscosity beads can prevent contact, and may result in premature failure).

When glue fixing panels to a solid substrate, first remove the back tissue. Use a hot iron or heat gun to soften the hot-melt adhesive layer, then gently peel off the tissue. This ensures that the adhesives bond to the glass fibre board. Failure to remove the tissue may result in poor adhesion and potential panel drop. Alternatively order the Cloud panels without the dust tissue backer and ensure the order includes FOR ADHESIVE INSTALLATION.

Mark out on the substrate where the Cloud panel will be attached as this will be required for accurate application of the contact glue on the substrate to match the same position on the Cloud panel (Option 1).

Lay the Cloud panel on a bench or other suitable surface taking care to protect the front surface.

Option 1

- Apply a liberal quantity of low viscosity construction adhesive around the perimeter approximately 75mm in from the edges, then in strips approximately 150mm apart. Flatten the bead if it looks too thick.
- Apply a heavy coat of the contact adhesive to the Cloud panel and to the same position on the substrate above. Allow the contact adhesive to tack off as per the manufacturer’s instructions.
- NOTE: take care when spraying not to overspray onto the side edges of the Cloud panel.
- With white gloves, use a panel lifter or two installers to lift the Cloud panel evenly and align with markings on the substrate. Press and hold across the panel to ensure the contact adhesive is together.

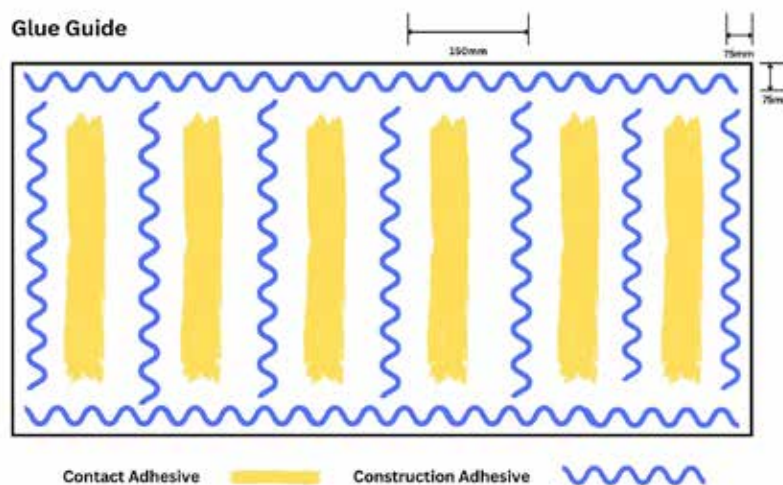

triton cloudTM panel

High Sound Absorbing Edge Wrapped Ceiling Panel

4.0 Installation

4.4 Direct Fixed with Adhesive—option 2

Installation shall not commence until the building is watertight and dry.

Installation Overview:

Triton Cloud Panels may be installed using an adhesives to direct fix to substrates. The substrates must be in a sound condition suitable to attach the Cloud panels, flat, free of dust and any oils or effervescence or any other substance that could prevent the adhesion. Construction adhesive type — a low viscosity type is required to allow “squash”.

When glue fixing panels to a solid substrate, first remove the back tissue. Use a hot iron or heat gun to soften the hot-melt adhesive layer, then gently peel off the tissue. This ensures that the adhesives bond to the glass fibre board. Failure to remove the tissue may result in poor adhesion and potential panel drop. Alternatively order the Cloud panels without the dust tissue backer and ensure the order includes FOR ADHESIVE INSTALLATION.

Mark out on the substrate where the Cloud panel will be attached as this will be required for accurate location.

Lay the Cloud panel on a bench or other suitable surface taking care to protect the front surface.

Option 2

- Apply the low viscosity construction adhesive across the back.
- Using a 6.5mm notched trowel, spread the adhesive 90% of the back surface.
- The “suction” effect of the area of adhesive should hold the panel in position while it sets. To ensure a satisfactory bond, use temporary support from the floor or across the ceiling, taking care not to mark the face.

Glue Guide

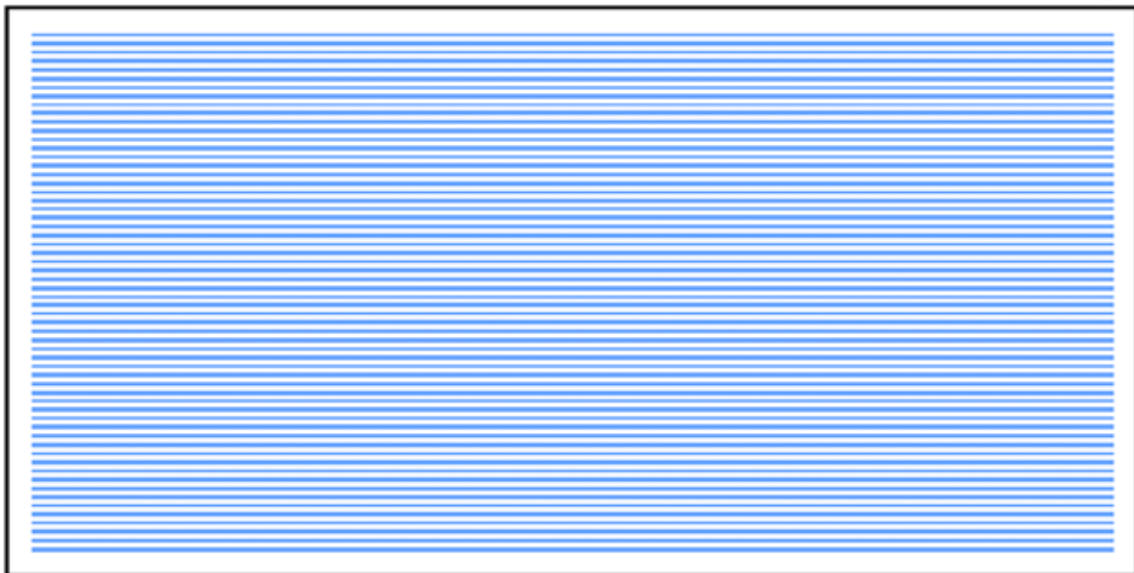

Construction Adhesive

Asona Ltd.
Office and Factory
6 Mahunga Drive, Māngere
Bridge, Auckland 2022
New Zealand

Contact
T: +64(0)9 525 6575
E: info@asona.co.nz
W: www.asona.co.nz
NZBN: 9429036035175

asona

triton cloudTM panel

High Sound Absorbing Edge Wrapped Ceiling Panel

4.5 Suspended Installation

Installation shall not commence until the building is watertight and dry.

Installation Overview:

Triton Cloud Panels may be installed suspended and attached with either standard $\varnothing 2.5$ suspension wire, or braided wire cable to different Rondo ceiling suspension system options.

Asona steel barbed plates are adhesively fixed to the rear of the panel. Use sections of Rondo DONN DX Main Tee or Rondo Key-Lock cut to length so they are not visible from below. Attach to the plates with 2 x No. 8 pan head (or similar) screws per plate.

Suspension hangers are attached to the substrate above at 1200mm centres maximum. Ensure all hangers are evenly adjusted.

NOTE: Standard $\varnothing 2.5$ suspension wire is shown. Braided wire maybe substituted for aesthetic appearance.

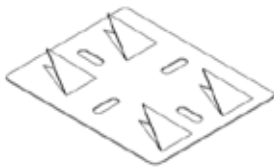

Barbed steel plate adhesively fixed to rear of Cloud Panels. Ensure barbs are alternately faced in opposite directions when attaching. Use good quality construction adhesive.

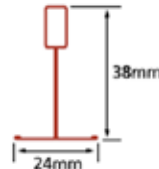

Rondo DONN DX Main Tee screwed to the barbed steel plates

Asona Triton Cloud Panel To Rondo KEY-LOCK (by Asona)

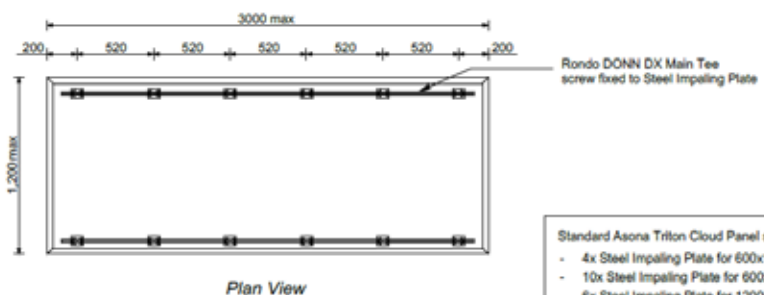
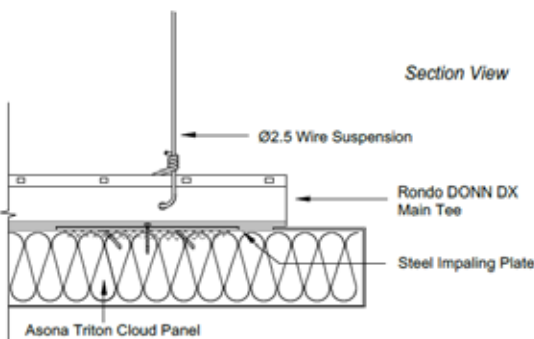
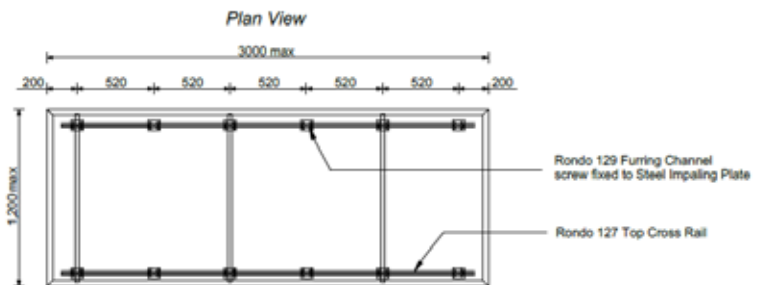
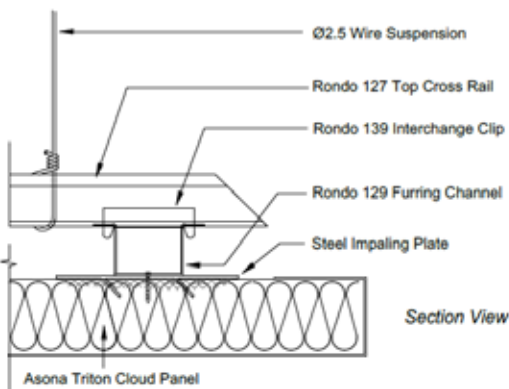

Asona Triton Cloud Panel To Rondo DONN DX (by Asona)

- Standard Asona Triton Cloud Panel sizes:
- 4x Steel Impaling Plate for 600x1200mm
 - 10x Steel Impaling Plate for 600x2400mm
 - 6x Steel Impaling Plate for 1200x1200mm
 - 10x Steel Impaling Plate for 1200x2400mm
 - 12x Steel Impaling Plate for 1200x3000mm

Asona Ltd.
Office and Factory
6 Mahunga Drive, Māngere
Bridge, Auckland 2022
New Zealand

Contact
T: +64(0)9 525 6575
E: info@asona.co.nz
W: www.asona.co.nz
NZBN: 9429036035175

asona

triton cloudTM panel

High Sound Absorbing Edge Wrapped Ceiling Panel

4.0 Installation

4.6 Suspended Installation to Steel Framed Cloud panels

Installation shall not commence until the building is watertight and dry.

Installation Overview:

Triton Cloud Panels may be installed suspended and attached with either standard $\text{Ø}2.5$ suspension wire, or braided wire cable. CL-BR20 angle brackets are attached to Cloud panels that have a concealed steel frame perimeter.

Suspension can be attached to the substrate above at 1200mm centres maximum. Ensure all hangers are evenly adjusted.

NOTE: Standard $\text{Ø}2.5$ suspension wire is shown. Braided wire maybe substituted for aesthetic appearance.

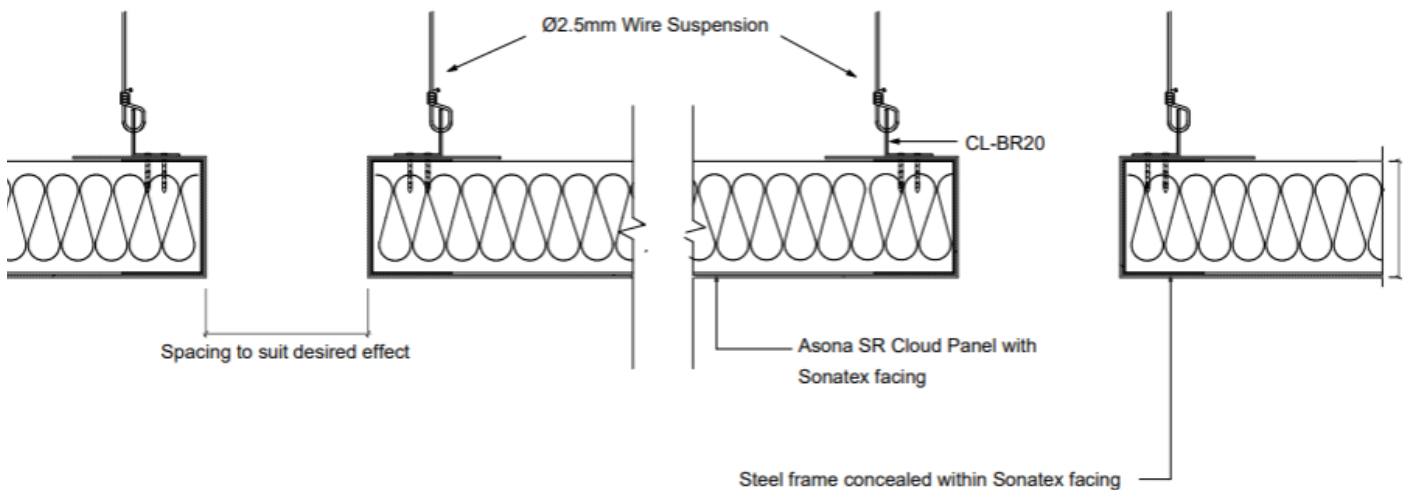

Brackets per Panel	Panel Size
4	600 x 1200
6	600 x 2400
4	1200 x 1200
6	1200 x 2400
8	1200 x 3000

Asona Ltd.
Office and Factory
6 Mahunga Drive, Māngere
Bridge, Auckland 2022
New Zealand

Contact
T: +64(0)9 525 6575
E: info@asona.co.nz
W: www.asona.co.nz
NZBN: 9429036035175

asona

triton cloudTM panel

High Sound Absorbing Edge Wrapped Ceiling Panel

4.0 Installation

4.7 Wall mounted Cloud panels

Installation shall not commence until the building is watertight and dry.

Installation Overview:

Triton Cloud Panels may be installed to high level walls above 2.4m.

They can be mounted to be permanently fixed or removable.

Option 1— permanently fixed

- Attach the 8-prong Impaling Plates using the appropriate fastener for the wall substrate type eg for plasterboard, wood, concrete etc.
- Apply a heavy coat of the construction adhesive to the Cloud panel as shown.
- Using white gloves, align the Cloud panel with pre-marked positioning and press the Cloud panel onto the 8-prong Impaling Plates until the panel is in full contact with the wall.

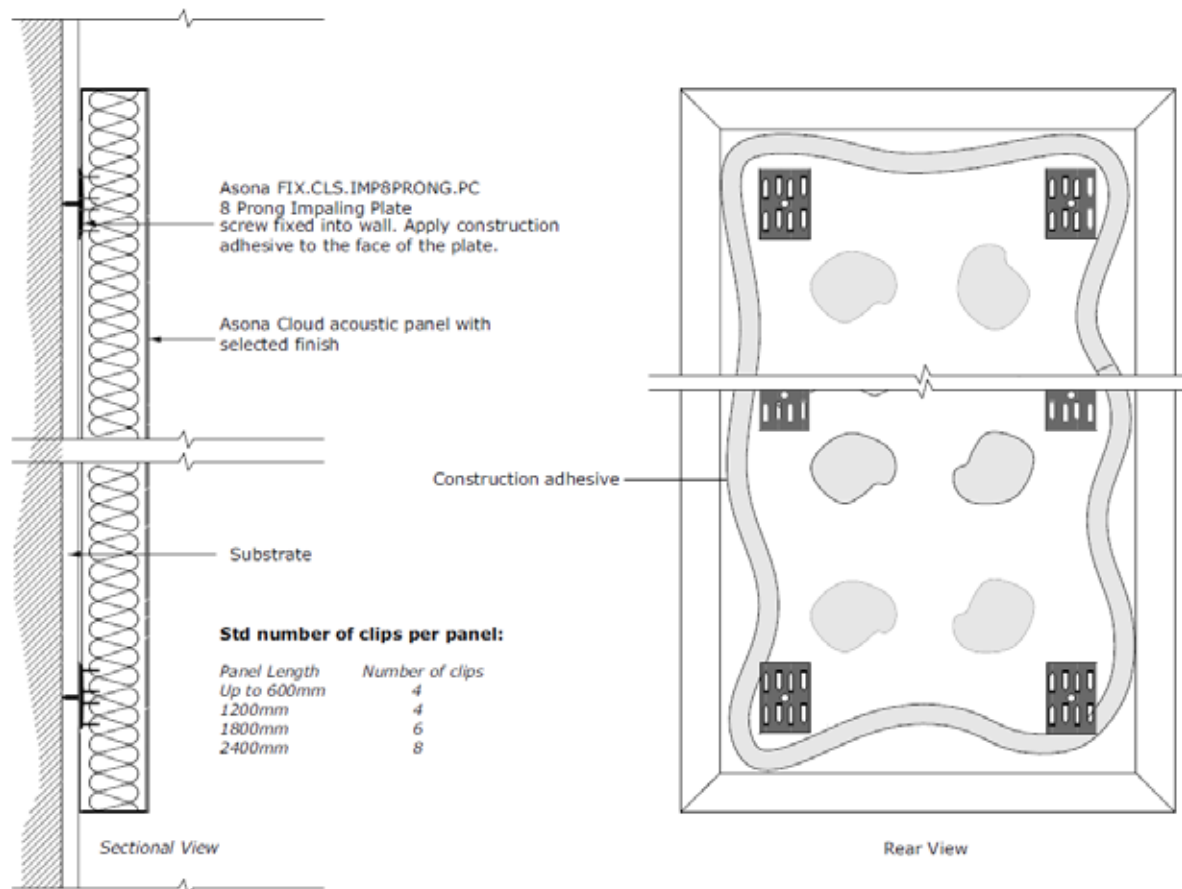
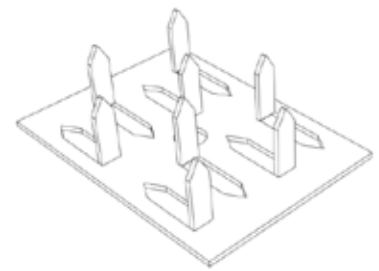

Asona Ltd.
Office and Factory
6 Mahunga Drive, Māngere
Bridge, Auckland 2022
New Zealand

Contact
T: +64(0)9 525 6575
E: info@asona.co.nz
W: www.asona.co.nz
NZBN: 9429036035175

asona

triton cloudTM panel

High Sound Absorbing Edge Wrapped Ceiling Panel

4.0 Installation

4.7 Wall mounted Cloud panels

Installation shall not commence until the building is watertight and dry.

Installation Overview:

Triton Cloud Panels may be installed to high level walls above 2.4m.

They can be mounted to be permanently fixed or removable.

Option 2 — removable, with Side Impaling Brackets

- Use the same installation details on pages 9-12 as for ceilings.
- Subject to panel size, an aluminium angle may be required as alternative support to the bottom edge.

Option 3 — removable, with Flat Plates

(steel framed panels only)

- Screw Flat Plates to top and bottom framing.
- Screw through the Flat Plate to wall with appropriate fastener type for lining substrate.

Option 4 — removable, with Split Rail Mounting

- Screw panel Split Rail to Barbed Steel Plates (see page 17). Ensure barbs face up for wall mounting.
- Screw wall Split Rail to wall lining.
- Subject to panel size, another Split Rail may be required as alternative support to the bottom edge.

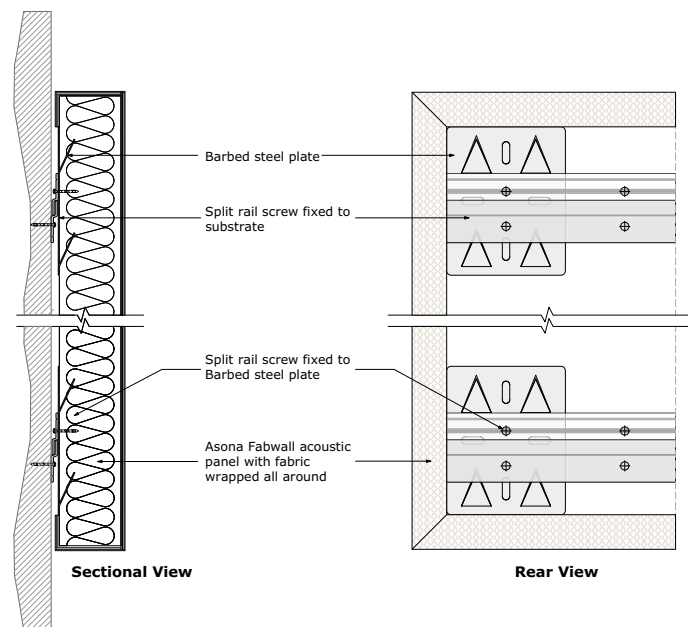
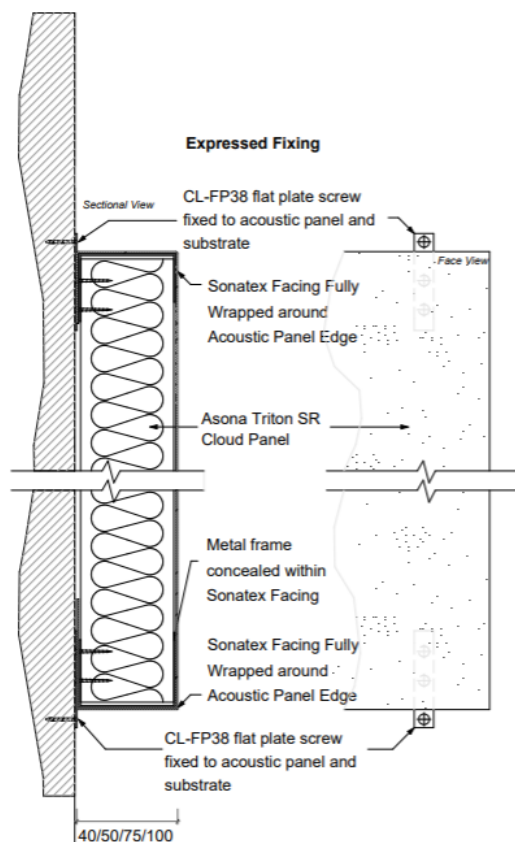

Asona Ltd.
Office and Factory
6 Mahunga Drive, Māngere
Bridge, Auckland 2022
New Zealand

Contact
T: +64(0)9 525 6575
E: info@asona.co.nz
W: www.asona.co.nz
NZBN: 9429036035175

asona

triton cloudTM panel

High Sound Absorbing Edge Wrapped Ceiling Panel

4.0 Installation

4.8 Installation of Services

Mechanical and electrical services and fire sprinklers shall ideally be positioned between panels and attached to the structure independent of the Triton Cloud Panel.

Exceptions may be made.

Sprinklers penetrations may be cut in the panel, ensure cut edges are covered by the escutcheon plate. For suspended Cloud panels, ensure both the Cloud panel and sprinkler penetration are braced equally. This may require the services of a Chartered Engineer to confirm bracing requirements to comply with NZBC seismic requirements.

For surface mounted lightweight fittings less than 1 kg, (such as smoke detectors), point loads shall be independently supported. A common method is to place a timber/MDF batten across the back of the panel, edge to edge. Screw through the panel into the batten using 65mm minimum screws (for 50mm Cloud).



Take care not to over tighten screws or to compress the face.

A similar method can be used for lightweight downlights or other lightweight items that may need to penetrate the Cloud panel. Carefully cut a clearance hole for the product so any escutcheon or trim covers the hole. Use a piece of 12-18mm MDF or ply full width across the back with a similar size hole for the product to pass through. The strip width should be 100mm minimum wider each side of the fitting. Secure the product to the back of the MDF/ply. Items of greater weight will required support from the structure above.

Mounting method for a smoke detector or similar light-weight product surface mounted on a Cloud panel.

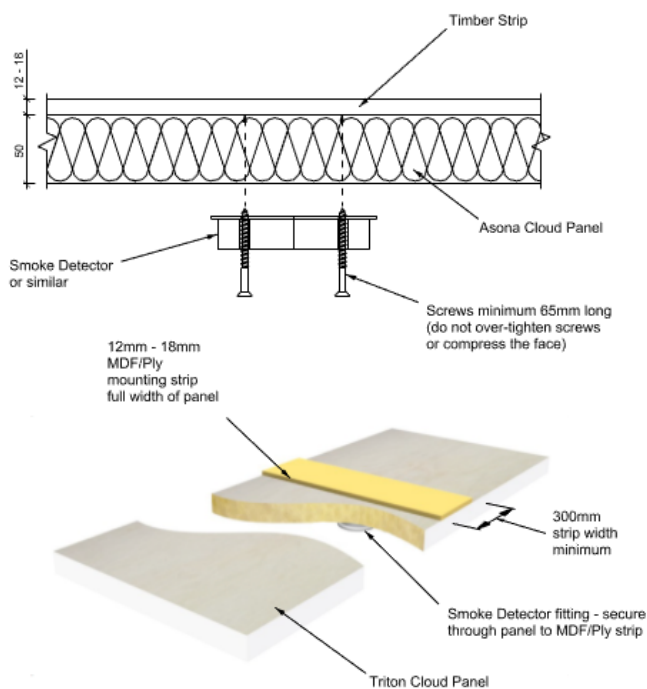

Mounting method for a downlight or similar light-weight product penetrating a Cloud panel.

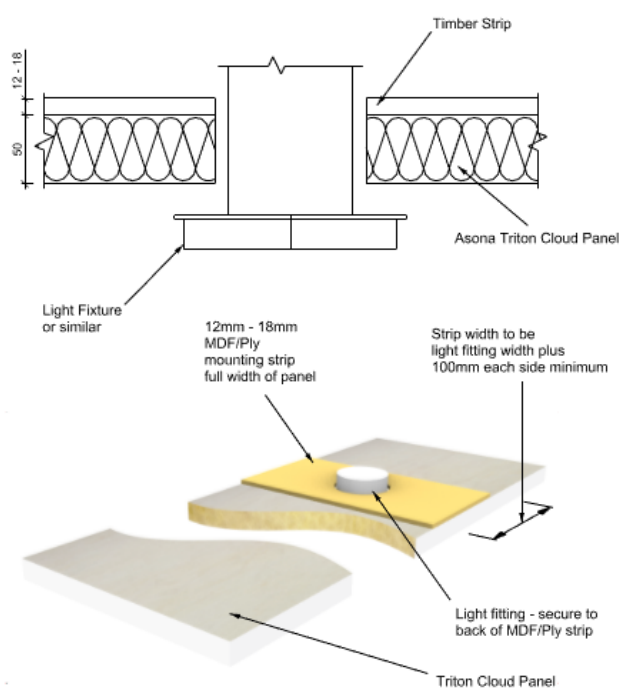

triton cloudTM panel

High Sound Absorbing Edge Wrapped Ceiling Panel

5.0 Cutting

5.0 Cutting

Cutting of panels shall be avoided where possible.

Custom made to measure panels are available, consult Asona.

If cutting of panels is required to adjust for onsite dimension, then you will need to follow the methods below. As any cut through the panel will expose the acoustic core, this step-by-step guide illustrates the tools and method required to trim and recover the exposed core of the Triton Cloud VG panels to maintain a consistent edge finish. There are two methods available, crease and fold (CF) or edge band (EB). For cuts less than 50 mm, diagonal and notched cuts, you will need to use the edge band method and purchase edge banding strips from Asona prior to carrying out works.

For additional assistance please consult Asona technical team.

Set up

Set up a clean work bench or cutting table with a clean flat surface, drop sheet to floor. Best cutting results are achieved when using a bench saw or plunge saw with guidance rail. Use a fine-tooth cutting blade and dust extractor. Protect the panel face with a cover sheet.

CF1 Site measure and marking

Note: For trim cuts less than 50 mm you will need to purchase and apply a Sonatex edge band strip. Refer to Edge Banding method in this document.

- Site measure the cut size required.
- Place the panel face down on the cutting table and measure actual thickness, this will determine the 2nd mark position.
- Make 2 marks on the back of the panel. These mark the position for 2 saw cuts. Do not mark the face side.
- The first mark will be the location for the finished trim size. Mark this dimension to the back of the panel using a straight edge and pencil.
- Make a second mark line 49-50 mm from the 1st line, this will be closer to the 'cut to waste' side.

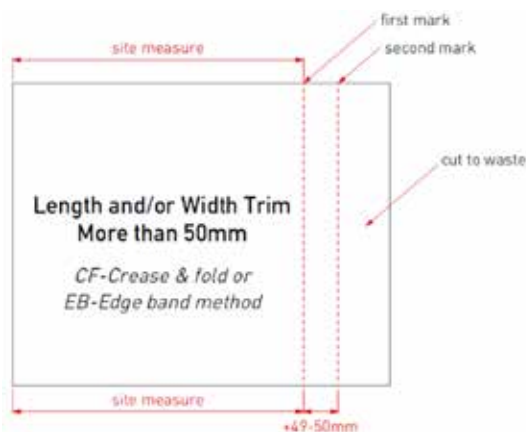

CF2 Cutting - cut to waste:

- Position the guide rail on the back of the panel to align with the 2nd marked line
- Set saw cut depth to 51-55 mm and carefully cut through the panel.
- Discard offcut to waste.



Asona Ltd.
Office and Factory
6 Mahunga Drive, Māngere
Bridge, Auckland 2022
New Zealand

Contact
T: +64(0)9 525 6575
E: info@asona.co.nz
W: www.asona.co.nz
NZBN: 9429036035175

asona

triton cloudTM panel

High Sound Absorbing Edge Wrapped Ceiling Panel

5.0 Cutting

CF3 Cutting - cut to finish size:

- Reposition the guide rail to align to the 1st mark.
 - Check the thickness of the panel and set the depth of the plunge saw to leave no less than 2.0mm from the face of the panel.
- NB: Take care not to cut through the Sonatex™ facing material as this is required to be folded and cover the acoustic core.



CF4 Removing the cut core:

- Use the utility knife blade and position horizontally. Using a 'filleting' action carefully cut between the Sonatex and the acoustic core. Take care not to cut into the facing.



triton cloudTM panel

High Sound Absorbing Edge Wrapped Ceiling Panel

5.0 Cutting

CF4 Removing the cut core cont.:

- Remove the cut section of the acoustic core and discard to waste.



CF5 Cleaning up the back of the Sonatex:

- Use the scraper tool to remove any excess acoustic core that remains on the back of the SonatexTM facing material.
- Take care not to damage the Sonatex facing material.

- The goal is to achieve a clean smooth surface.



triton cloudTM panel

High Sound Absorbing Edge Wrapped Ceiling Panel

5.0 Cutting

CF6 Creasing the back of the Sonatex™ facing:

- Use the putty knife to gently crease a fold line in the back of the Sonatex at the intersection with the acoustic core board.
- Make sure the blade is vertical and square to the core board.
- Use a slow and gentle scoring action and make 1 or 2 passes. **Do not over pressure the tool as this may cut through the facing.**
- Put on the clean gloves and carefully make a hand fold to check that the fold line is straight and that corners align with no gaps. Work from the centre to the edge.



CF7 Applying the adhesive:

- Spray contact adhesive to the exposed acoustic core and back of the Sonatex facing taking care not to over spray onto the decorative side. Use masking tape if required.
 - Spray a double pass to ensure sufficient adhesive coverage to ensure a strong bond.
 - Allow time for the adhesive to tack off (usually no longer than 2 minutes).
- N.B Check adhesive manufacture directions before applying adhesive.



triton cloudTM panel

High Sound Absorbing Edge Wrapped Ceiling Panel

5.0 Cutting

CF8 CF8 Folding and fixing the new edge:

- Wearing clean white gloves and working from the centre, fold up the Sonatex facing to the acoustic core.
- Apply hand pressure to ensure a positive bond. Take care to ensure the corners align and are formed neatly.
- If any excess extends above the back of the panel then use a medium to fine (180- 220 grit) sanding block to buff and tidy the edge.



CF9 Turn the panel over and inspect the facing and the newly folded edge.

Carefully remove any over spray and clean up any finger marks by buffing the panel with a piece of Sonatex™ or 'magic sponge' cleaner.

The Triton 50 VG Cloud panel is now ready for installation.



triton cloudTM panel

High Sound Absorbing Edge Wrapped Ceiling Panel

5.0 Cutting

EB Edge Band method:

From time to time you may be required to trim less than 50 mm or make diagonal or notched cuts into the acoustic panel.

Use the edge banding method to achieve these on site.

You will need to pre-purchase Sonatex edge banding strips from Asona prior to carrying out works.

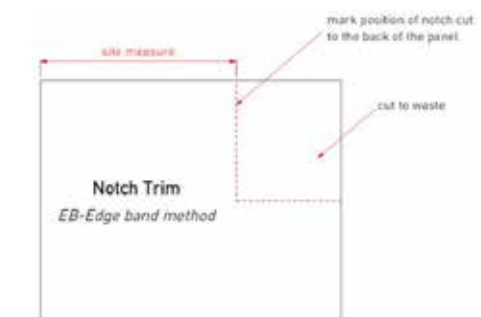
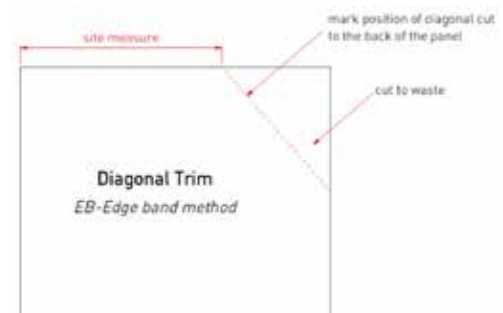
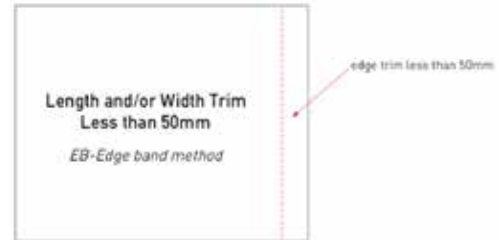

EB1 Cutting - cut to finish size:

- Site measure to determine the finished panel size. Mark the position on the back of the panel.
- Using the method as described in point CF2 above cut through the full depth of the panel with a plunge saw. The objective is to achieve straight square cut face. Discard offcut to waste.



triton cloudTM panel

High Sound Absorbing Edge Wrapped Ceiling Panel

5.0 Cutting

EB2 Cut edge band to length:

- Measure the cut length of panel and cut a length of Sonatex edge band to suit. Allow 20mm extra to be trimmed later.

N.B SonatexTM edge banding is supplied in 1230 x 60 mm strips to allow for trimming on site. For long cuts butt join edging on site. Long lengths available to order, MOQ 40 pcs, consult Asona.



EB3 Applying the adhesive:

- Ensure the acoustic core is free from loose dust.
- Spray contact adhesive to the exposed acoustic core and back of the Sonatex edge banding taking care not to over spray onto the decorative side. Use low tack masking tape if required.
- Make a double pass to ensure sufficient adhesive coverage to ensure a strong bond.
- Allow time for the adhesive to tack off (usually, no longer than 2 minutes).

N.B Check adhesive manufacture directions before applying adhesive.



EB4 Bonding the edge band:

- Bond the Sonatex edge band to the acoustic core. Take care to control the edge as it is applied to ensure it covers the core.
- Apply hand pressure for a positive bond.



triton cloudTM panel

High Sound Absorbing Edge Wrapped Ceiling Panel

5.0 Cutting

EB5 Trim and sand the edge:

Carefully trim away the excess Sonatex edge band using the sharp utility knife.

Good knife control is required to avoid cutting into the face, use a flat edge as a guide if required.

Use a medium to fine (180- 220 grit) sanding block paper to buff and tidy the edge.

N.B Do not over sand as this can expose the acoustic core.



EB6 QA:

Turn the panel over and inspect the facing and the edge. Carefully remove any over spray and clean up any finger marks by buffing the panel with a piece of Sonatex or 'magic sponge' cleaner.

Finished panel is ready for installation.



triton cloudTM panel

High Sound Absorbing Edge Wrapped Ceiling Panel

6.0 Access Panels

6.0 Access Panels

Access panels in Triton Cloud panels shall be avoided where possible.
Screw fixed panels may be demounted to gain access above.

Cloud panels covering proprietary access hatches in a fully lined ceiling (e.g. plasterboard) can have a 600 x 600mm maximum Cloud “access panel” magnetically fixed to cover the hatch.
Consult Asona.

triton cloudTM panel

High Sound Absorbing Edge Wrapped Ceiling Panel

7.0 Tools

Box Cutter, Knife, Utility Knife.



Tape Measure



Pencil



Tee Square



Sliding adjustable drop saw with dust extraction and fine tooth saw blade (eg Festool / DeWalt)



Fine Tooth Hole Saw (10 tpi bi metal)



Asona Ltd.
Office and Factory
6 Mahunga Drive, Māngere
Bridge, Auckland 2022
New Zealand







Contact
T: +64(0)9 525 6575
E: info@asona.co.nz
W: www.asona.co.nz
NZBN: 9429036035175

asona

triton cloudTM panel

High Sound Absorbing Edge Wrapped Ceiling Panel

7.0 Tools

Fine/medium sanding block	
Scraper	
Soft nose spatula or putty knife for creasing	
CANTAC HSE-TAC Aerosol Contact Adhesive 575ml – or equal	
Clean white gloves Eye protection Dust mask	
90° Power Drill	

Asona Ltd.
Office and Factory
6 Mahunga Drive, Māngere
Bridge, Auckland 2022
New Zealand

Contact
T: +64(0)9 525 6575
E: info@asona.co.nz
W: www.asona.co.nz
NZBN: 9429036035175

